

SAFETY EQUIPMENT

Quick Overview

EARTHING AND SHORT-CIRCUITING DEVICES

EN/IEC 61230 (DIN VDE 0683 Part 100)

Components	Type	Page	Phase connecting elements
Earthing and Short-Circuiting Devices			
Ball Head Cap, rigid, hexagon Shaft	Three-pole	104	
	Single-pole	114	
Ball Head Cap, rigid, T pin Shaft	Three-pole	105	
	Single-pole	115	
Earthing and Short-Circuiting Devices			
Ball Head Cap, adjustable (4 x 90°), hexagon Shaft	Three-pole	106	
	Single-pole	116	
Ball Head Cap, adjustable (4 x 90°), T pin Shaft	Three-pole	107	
	Single-pole	117	
Earthing and Short-Circuiting Devices			
Universal Clamp, Clamping Range 20 / 25 mm, hexagon Shaft	Three-pole	108	
	Single-pole	118	
Universal Clamp, Clamping Range 20 / 25 mm, T pin Shaft	Three-pole	109	
	Single-pole	119	
Earthing and Short-Circuiting Devices			
Universal Clamp, Clamping Range 25 / 30 mm, hexagon Shaft	Three-pole	110	
	Single-pole	120	
Universal Clamp, Clamping Range 25 / 30 mm, T pin Shaft	Three-pole	111	
	Single-pole	121	

Three-pole Earthing and Short-circuiting Devices

SAFETY EQUIPMENT

Ball head cap, rigid, hexagon shaft EARTHING AND SHORT-CIRCUITING DEVICES

EN/IEC 61230 (DIN VDE 0683 Part 100)

Phase connecting elements



Fixed ball point Ø	Cable cross section	Max. short-circuit current I_k 1 s	Part No.	Part No.	Part No.
20 mm	25/25 mm ²	4.9 kA	725 618	725 317	725 358
20 mm	35/35 mm ²	6.9 kA	735 618	735 317	735 358
20 mm	50/25 mm ²	9.9 kA	750 350	750 317	750 358
20 mm	70/35 mm ²	13.8 kA	770 350	770 317	770 358
20 mm	95/35 mm ²	18.7 kA	794 350	794 317	794 358
20 mm	120/50 mm ²	23.7 kA	711 350	711 317	711 358
25 mm	95/35 mm ²	18.7 kA	795 350	795 317	795 358
25 mm	120/50 mm ²	23.7 kA	712 350	712 317	712 358
25 mm	150/50 mm ²	29.6 kA	715 350	715 317	715 358

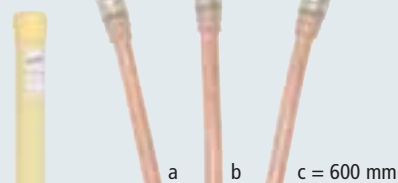

Fixed ball point Ø	Cable cross section	Max. short-circuit current I_k 1 s	Part No.	Part No.	Part No.
20 mm	25/25 mm ²	4.9 kA	725 362	725 363	725 360
20 mm	35/35 mm ²	6.9 kA	735 362	735 363	735 360
20 mm	50/25 mm ²	9.9 kA	750 362	750 363	750 360
20 mm	70/35 mm ²	13.8 kA	770 362	770 363	770 360
20 mm	95/35 mm ²	18.7 kA	794 362	794 363	794 360
20 mm	120/50 mm ²	23.7 kA	711 362	711 363	711 360
25 mm	95/35 mm ²	18.7 kA	795 362	795 363	795 360
25 mm	120/50 mm ²	23.7 kA	712 362	712 363	712 360
25 mm	150/50 mm ²	29.6 kA	715 362	715 363	715 360

d = 1800 mm



Fixed ball point Ø	Cable cross section	Max. short-circuit current I_k 1 s	Part No.	Part No.	Part No.
20 mm	25/25 mm ²	4.9 kA	725 619	725 357	725 359
20 mm	35/35 mm ²	6.9 kA	735 619	735 357	735 359
20 mm	50/25 mm ²	9.9 kA	750 356	750 357	750 359
20 mm	70/35 mm ²	13.8 kA	770 356	770 357	770 359
20 mm	95/35 mm ²	18.7 kA	794 356	794 357	794 359
20 mm	120/50 mm ²	23.7 kA	711 356	711 357	711 359
25 mm	95/35 mm ²	18.7 kA	795 356	795 357	795 359
25 mm	120/50 mm ²	23.7 kA	712 356	712 357	712 359
25 mm	150/50 mm ²	29.6 kA	715 356	715 357	715 359

Earth connecting elements



EAS EK FM 12



EAS EK FS 12



EAB RN 16 FS



EAS EK FM 16



EAS EK FS 16



EFK FL30 SKN

KKH 20 FS
KKH 25 FSKKH 20 HG
KKH 25 HGUEK 25 FS
UEK 30 FS

Other cable lengths as well as types with unreduced cross sections of earthing cables, other earth clamps and earth connection units are available on request. Earthing rod is not included in delivery.

SAFETY EQUIPMENT

Three-pole Earthing and Short-Circuiting Devices

EARTHING AND SHORT-CIRCUITING DEVICES

Ball head cap, rigid, T pin shaft

EN/IEC 61230 (DIN VDE 0683 Part 100)

Earth connecting elements

Phase connecting elements



EAS EK FM 12



EAS EK FS 12



EAB RN 16 FS

Fixed ball point Ø	Cable cross section	Max. short-circuit current I_k 1 s
20 mm	25/25 mm ²	4.9 kA
20 mm	35/35 mm ²	6.9 kA
20 mm	50/25 mm ²	9.9 kA
20 mm	70/35 mm ²	13.8 kA
20 mm	95/35 mm ²	18.7 kA
20 mm	120/50 mm ²	23.7 kA
25 mm	95/35 mm ²	18.7 kA
25 mm	120/50 mm ²	23.7 kA
25 mm	150/50 mm ²	29.6 kA

Part No.	Part No.	Part No.
725 620	725 365	725 368
735 620	735 365	735 368
750 351	750 365	750 368
770 351	770 365	770 368
794 351	794 365	794 368
711 351	711 365	711 368
795 351	795 365	795 368
712 351	712 365	712 368
715 351	715 365	715 368

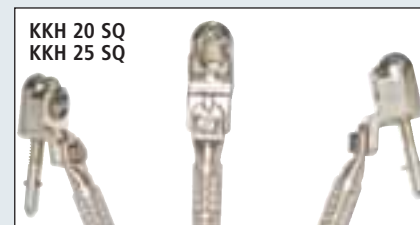
KKH 20 SQ
KKH 25 SQ

EAS EK FM 16



EAS EK FS 16



EFK FL30 SKN

Fixed ball point Ø	Cable cross section	Max. short-circuit current I_k 1 s
20 mm	25/25 mm ²	4.9 kA
20 mm	35/35 mm ²	6.9 kA
20 mm	50/25 mm ²	9.9 kA
20 mm	70/35 mm ²	13.8 kA
20 mm	95/35 mm ²	18.7 kA
20 mm	120/50 mm ²	23.7 kA
25 mm	95/35 mm ²	18.7 kA
25 mm	120/50 mm ²	23.7 kA
25 mm	150/50 mm ²	29.6 kA

Part No.	Part No.	Part No.
725 372	725 373	725 370
735 372	735 373	735 370
750 372	750 373	750 370
770 372	770 373	770 370
794 372	794 373	794 370
711 372	711 373	711 370
795 372	795 373	795 370
712 372	712 373	712 370
715 372	715 373	715 370

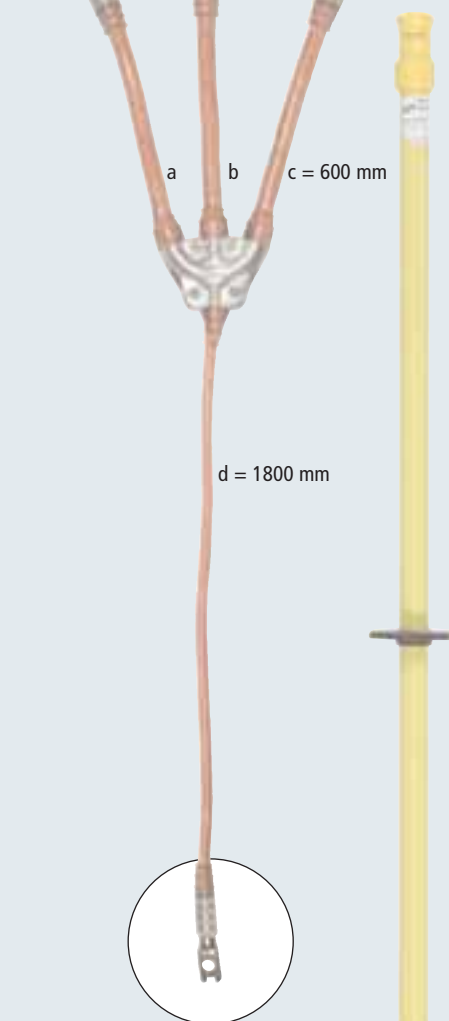
KKH 20 FS
KKH 25 FSKKH 20 HG
KKH 25 HGUEK 25 FS
UEK 30 FS

Fixed ball point Ø	Cable cross section	Max. short-circuit current I_k 1 s
20 mm	25/25 mm ²	4.9 kA
20 mm	35/35 mm ²	6.9 kA
20 mm	50/25 mm ²	9.9 kA
20 mm	70/35 mm ²	13.8 kA
20 mm	95/35 mm ²	18.7 kA
20 mm	120/50 mm ²	23.7 kA
25 mm	95/35 mm ²	18.7 kA
25 mm	120/50 mm ²	23.7 kA
25 mm	150/50 mm ²	29.6 kA

Part No.	Part No.	Part No.
725 621	725 367	725 369
735 621	735 367	735 369
750 366	750 367	750 369
770 366	770 367	770 369
794 366	794 367	794 369
711 366	711 367	711 369
795 366	795 367	795 369
712 366	712 367	712 369
715 366	715 367	715 369

Other cable lengths as well as types with unreduced cross sections of earthing cables, other earth clamps and earth connection units are available on request. Earthing rod is not included in delivery.

Three-pole Earthing and Short-circuiting Devices

SAFETY EQUIPMENT

Ball head cap, adjustable (4 x 90°), hexagon shaft

IEC/EN 61230 (DIN VDE 0683 Part 100)

Phase connecting elements

Earth connecting elements



EAS EK FM 12



EAS EK FS 12



EAB RN 16 FS

KKH 20 D SK
KKH 25 D SK

Fixed ball point Ø	Cable cross section	Max. short-circuit current I_k 1 s	Part No.	Part No.	Part No.
20 mm	25/25 mm ²	4.9 kA	725 718	725 375	725 378
20 mm	35/35 mm ²	6.9 kA	735 718	735 375	735 378
20 mm	50/25 mm ²	9.9 kA	750 353	750 375	750 378
20 mm	70/35 mm ²	13.8 kA	770 353	770 375	770 378
20 mm	95/35 mm ²	18.7 kA	794 353	794 375	794 378
20 mm	120/50 mm ²	23.7 kA	711 353	711 375	711 378
25 mm	95/35 mm ²	18.7 kA	795 374	795 375	795 378
25 mm	120/50 mm ²	23.7 kA	712 374	712 375	712 378
25 mm	150/50 mm ²	29.6 kA	715 374	715 375	715 378

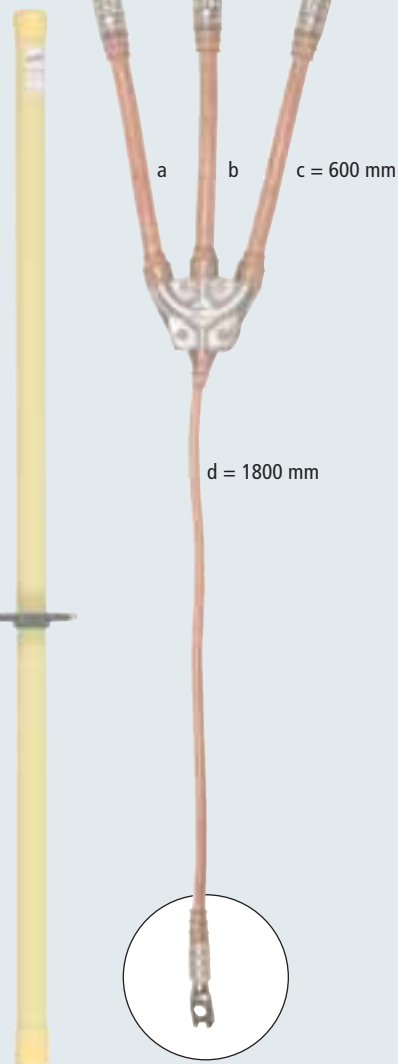

EAS EK FM 16



EAS EK FS 16



EFK FL30 SKN

Fixed ball point Ø	Cable cross section	Max. short-circuit current I_k 1 s	Part No.	Part No.	Part No.
20 mm	25/25 mm ²	4.9 kA	725 382	725 383	725 380
20 mm	35/35 mm ²	6.9 kA	735 382	735 383	735 380
20 mm	50/25 mm ²	9.9 kA	750 382	750 383	750 380
20 mm	70/35 mm ²	13.8 kA	770 382	770 383	770 380
20 mm	95/35 mm ²	18.7 kA	794 382	794 383	794 380
20 mm	120/50 mm ²	23.7 kA	711 382	711 383	711 380
25 mm	95/35 mm ²	18.7 kA	795 382	795 383	795 380
25 mm	120/50 mm ²	23.7 kA	712 382	712 383	712 380
25 mm	150/50 mm ²	29.6 kA	715 382	715 383	715 380

KKH 20 FS
KKH 25 FSKKH 20 HG
KKH 25 HGUEK 25 FS
UEK 30 FS

Fixed ball point Ø	Cable cross section	Max. short-circuit current I_k 1 s	Part No.	Part No.	Part No.
20 mm	25/25 mm ²	4.9 kA	725 719	725 377	725 379
20 mm	35/35 mm ²	6.9 kA	735 719	735 377	735 379
20 mm	50/25 mm ²	9.9 kA	750 376	750 377	750 379
20 mm	70/35 mm ²	13.8 kA	770 376	770 377	770 379
20 mm	95/35 mm ²	18.7 kA	794 376	794 377	794 379
20 mm	120/50 mm ²	23.7 kA	711 376	711 377	711 379
25 mm	95/35 mm ²	18.7 kA	795 376	795 950	795 379
25 mm	120/50 mm ²	23.7 kA	712 376	712 950	712 379
25 mm	150/50 mm ²	29.6 kA	715 376	715 950	715 379

Other cable lengths as well as types with unreduced cross sections of earthing cables, other earth clamps and earth connection units are available on request. Earthing rod is not included in delivery.

SAFETY EQUIPMENT

Three-pole Earthing and Short-circuiting Devices

EARTHING AND SHORT-CIRCUITING DEVICES

Ball head cap, adjustable (4 x 90°),
T pin shaft

IEC/EN 61230 (DIN VDE 0683 Part 100)

Earth connecting elements

Phase connecting elements



EAS EK FM 12



EAS EK FS 12



EAB RN 16 FS

Fixed ball point Ø	Cable cross section	Max. short-circuit current I_k 1 s
20 mm	25/25 mm ²	4.9 kA
20 mm	35/35 mm ²	6.9 kA
20 mm	50/25 mm ²	9.9 kA
20 mm	70/35 mm ²	13.8 kA
20 mm	95/35 mm ²	18.7 kA
20 mm	120/50 mm ²	23.7 kA
25 mm	95/35 mm ²	18.7 kA
25 mm	120/50 mm ²	23.7 kA
25 mm	150/50 mm ²	29.6 kA

Part No.	Part No.	Part No.
725 720	725 385	725 388
735 720	735 385	735 388
750 354	750 385	750 388
770 354	770 385	770 388
794 354	794 385	794 388
711 354	711 385	711 388
795 384	795 385	795 388
712 384	712 385	712 388
715 384	715 385	715 388

KKH 20 D SQ
KKH 25 D SQ

EAS EK FM 16



EAS EK FS 16



EFK FL30 SKN

Fixed ball point Ø	Cable cross section	Max. short-circuit current I_k 1 s
20 mm	25/25 mm ²	4.9 kA
20 mm	35/35 mm ²	6.9 kA
20 mm	50/25 mm ²	9.9 kA
20 mm	70/35 mm ²	13.8 kA
20 mm	95/35 mm ²	18.7 kA
20 mm	120/50 mm ²	23.7 kA
25 mm	95/35 mm ²	18.7 kA
25 mm	120/50 mm ²	23.7 kA
25 mm	150/50 mm ²	29.6 kA

Part No.	Part No.	Part No.
725 392	725 393	725 390
735 392	735 393	735 390
750 392	750 393	750 390
770 392	770 393	770 390
794 392	794 393	794 390
711 392	711 393	711 390
795 392	795 393	795 390
712 392	712 393	712 390
715 392	715 393	715 390

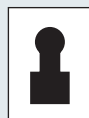
KKH 20 FS
KKH 25 FSKKH 20 HG
KKH 25 HGUEK 25 FS
UEK 30 FS

Fixed ball point Ø	Cable cross section	Max. short-circuit current I_k 1 s
20 mm	25/25 mm ²	4.9 kA
20 mm	35/35 mm ²	6.9 kA
20 mm	50/25 mm ²	9.9 kA
20 mm	70/35 mm ²	13.8 kA
20 mm	95/35 mm ²	18.7 kA
20 mm	120/50 mm ²	23.7 kA
25 mm	95/35 mm ²	18.7 kA
25 mm	120/50 mm ²	23.7 kA
25 mm	150/50 mm ²	29.6 kA

Part No.	Part No.	Part No.
725 721	725 387	725 389
735 721	735 387	735 389
750 386	750 387	750 389
770 386	770 387	770 389
794 386	794 387	794 389
711 386	711 387	711 389
795 386	795 951	795 389
712 386	712 951	712 389
715 386	715 951	715 389

Other cable lengths as well as types with unreduced cross sections of earthing cables, other earth clamps and earth connection units are available on request. Earthing rod is not included in delivery.

Three-pole Earthing and Short-circuiting Devices

Universal clamp, clamping range 20 / 25 mm, hexagon shaft

Phase connecting elements

EARTHING AND SHORT-CIRCUITING DEVICES

IEC/EN 61230 (DIN VDE 0683 Part 100)

Earth connecting elements



EAS EK FM 12



EAB RN 16 FS

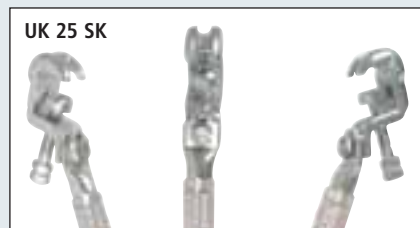

UK 25 SK

Fixed ball point Ø	Phase T pin Collar width	Rd / Fl Clamping range	Cable cross section	Max. short-circuit current I_k 1 s
20 / 25 mm	15 mm	20 mm	25/25 mm ²	4.9 kA
20 / 25 mm	15 mm	20 mm	35/35 mm ²	6.9 kA
20 / 25 mm	15 mm	20 mm	50/25 mm ²	9.9 kA
20 / 25 mm	15 mm	20 mm	70/35 mm ²	13.8 kA
20 / 25 mm	15 mm	—	95/35 mm ²	18.7 kA
— / 25 mm	—	—	120/50 mm ²	23.7 kA

Part No.	Part No.
725 823	725 826
735 823	735 826
750 823	750 826
770 823	770 826
795 823	795 826
712 843	712 846

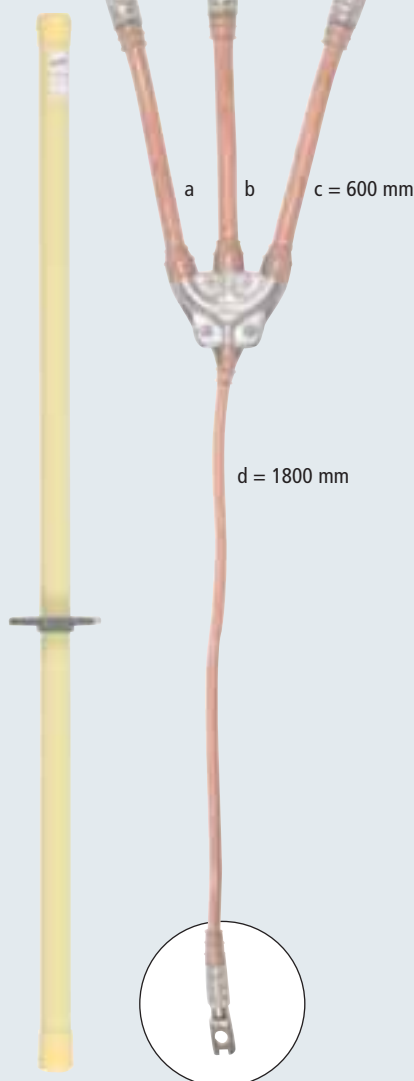

UEK 25 FS



EFK FL30 SKN

Fixed ball point Ø	Phase T pin Collar width	Rd / Fl Clamping range	Cable cross section	Max. short-circuit current I_k 1 s
20 / 25 mm	15 mm	20 mm	25/25 mm ²	4.9 kA
20 / 25 mm	15 mm	20 mm	35/35 mm ²	6.9 kA
20 / 25 mm	15 mm	20 mm	50/25 mm ²	9.9 kA
20 / 25 mm	15 mm	20 mm	70/35 mm ²	13.8 kA
20 / 25 mm	15 mm	—	95/35 mm ²	18.7 kA
— / 25 mm	—	—	120/50 mm ²	23.7 kA

Part No.	Part No.
725 822	725 821
735 822	735 821
750 822	750 821
770 822	770 821
795 822	795 821
712 842	712 841



UEK 25 HG

Fixed ball point Ø	Phase T pin Collar width	Rd / Fl Clamping range	Cable cross section	Max. short-circuit current I_k 1 s
20 / 25 mm	15 mm	20 mm	25/25 mm ²	4.9 kA
20 / 25 mm	15 mm	20 mm	35/35 mm ²	6.9 kA
20 / 25 mm	15 mm	20 mm	50/25 mm ²	9.9 kA
20 / 25 mm	15 mm	20 mm	70/35 mm ²	13.8 kA
20 / 25 mm	15 mm	—	95/35 mm ²	18.7 kA
— / 25 mm	—	—	120/50 mm ²	23.7 kA

Part No.
725 825
735 825
750 825
770 825
795 825
712 845

Other cable lengths as well as types with unreduced cross sections of earthing cables or other earth clamps and earth connection units are available on request. Earthing rod is not included in delivery.

SAFETY EQUIPMENT

Three-pole Earthing and Short-circuiting Devices

EARTHING AND SHORT-CIRCUITING DEVICES

Universal clamp, clamping
range 20 / 25 mm, T pin shaft

IEC/EN 61230 (DIN VDE 0683 Part 100)

Earth connecting elements

Phase connecting elements



EAS EK FM 12



EAB RN 16 FS

Fixed ball point Ø	Phase T pin Collar width	Rd / Fl Clamping range	Cable cross section	Max. short-circuit current I _k 1 s
20 / 25 mm	15 mm	20 mm	25/25 mm ²	4.9 kA
20 / 25 mm	15 mm	20 mm	35/35 mm ²	6.9 kA
20 / 25 mm	15 mm	20 mm	50/25 mm ²	9.9 kA
20 / 25 mm	15 mm	20 mm	70/35 mm ²	13.8 kA
20 / 25 mm	15 mm	—	95/35 mm ²	18.7 kA
— / 25 mm	—	—	120/50 mm ²	23.7 kA

Part No.	Part No.
725 833	725 836
735 833	735 836
750 833	750 836
770 833	770 836
795 833	795 836
712 863	712 866



UK 25 SQ



UEK 25 FS



EFK FL30 SKN

Fixed ball point Ø	Phase T pin Collar width	Rd / Fl Clamping range	Cable cross section	Max. short-circuit current I _k 1 s
20 / 25 mm	15 mm	20 mm	25/25 mm ²	4.9 kA
20 / 25 mm	15 mm	20 mm	35/35 mm ²	6.9 kA
20 / 25 mm	15 mm	20 mm	50/25 mm ²	9.9 kA
20 / 25 mm	15 mm	20 mm	70/35 mm ²	13.8 kA
20 / 25 mm	15 mm	—	95/35 mm ²	18.7 kA
— / 25 mm	—	—	120/50 mm ²	23.7 kA

Part No.	Part No.
725 832	725 831
735 832	735 831
750 832	750 831
770 832	770 831
795 832	795 831
712 862	712 861

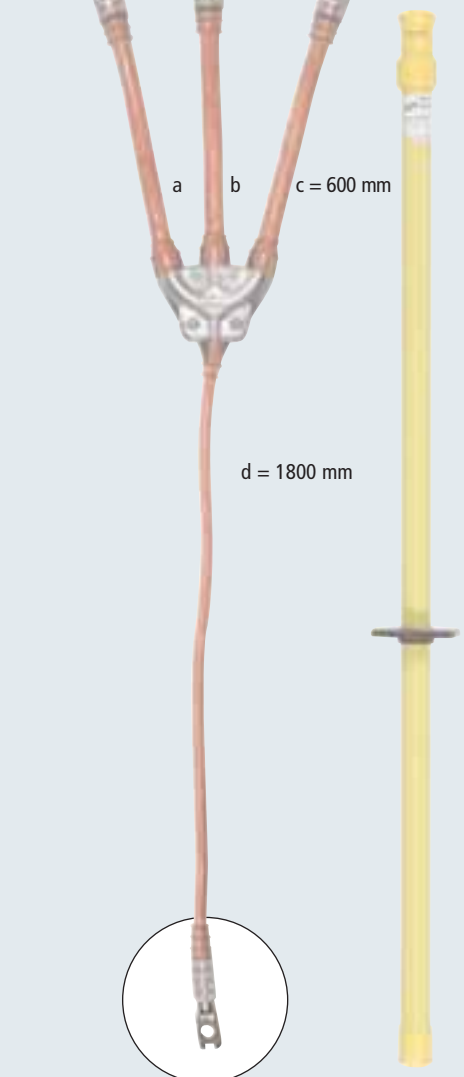

UEK 25 HG

Fixed ball point Ø	Phase T pin Collar width	Rd / Fl Clamping range	Cable cross section	Max. short-circuit current I _k 1 s
20 / 25 mm	15 mm	20 mm	25/25 mm ²	4.9 kA
20 / 25 mm	15 mm	20 mm	35/35 mm ²	6.9 kA
20 / 25 mm	15 mm	20 mm	50/25 mm ²	9.9 kA
20 / 25 mm	15 mm	20 mm	70/35 mm ²	13.8 kA
20 / 25 mm	15 mm	—	95/35 mm ²	18.7 kA
— / 25 mm	—	—	120/50 mm ²	23.7 kA

Part No.
725 835
735 835
750 835
770 835
795 835
712 865

Other cable lengths as well as types with unreduced cross sections of earthing cables, other earth clamps and earth connection units are available on request. Earthing rod is not included in delivery.

Three-pole Earthing and Short-circuiting Devices

Universal clamp, clamping range 25 / 30 mm, hexagon shaft

Phase connecting elements

SAFETY EQUIPMENT EARTHING AND SHORT-CIRCUITING DEVICES

IEC/EN 61230 (DIN VDE 0683 Part 100)

Earth connecting elements



EAS EK FM 12



EAB RN 16 FS

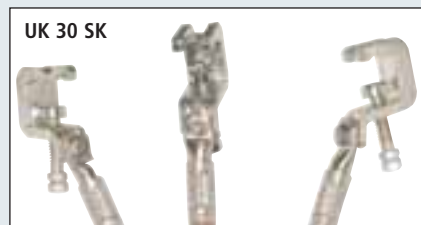

Fixed ball point Ø	Phase T pin Collar width	Rd / Fl Clamping range	Cable cross section	Max. short-circuit current I_k 1 s	Part No.	Part No.
25 / 30 mm	18 mm	30 mm	25/25 mm ²	4.9 kA	725 804	725 807
25 / 30 mm	18 mm	30 mm	35/35 mm ²	6.9 kA	735 804	735 807
25 / 30 mm	18 mm	30 mm	50/25 mm ²	9.9 kA	750 804	750 807
25 / 30 mm	18 mm	30 mm	70/35 mm ²	13.8 kA	770 804	770 807
25 / 30 mm	18 mm	—	95/35 mm ²	18.7 kA	795 804	795 807
25 / 30 mm	—	—	120/50 mm ²	23.7 kA	712 804	712 807

Part No.	Part No.
725 804	725 807
735 804	735 807
750 804	750 807
770 804	770 807
795 804	795 807
712 804	712 807

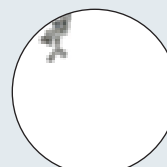
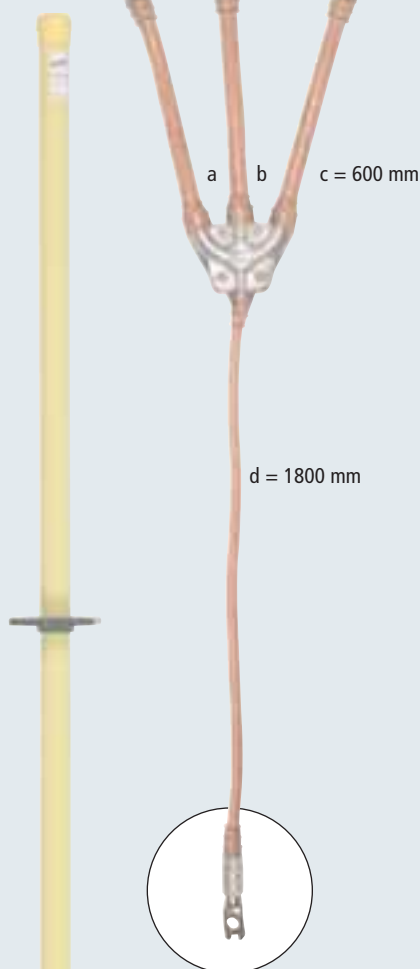

UEK 30 FS



EFK FL30 SKN

Fixed ball point Ø	Phase T pin Collar width	Rd / Fl Clamping range	Cable cross section	Max. short-circuit current I_k 1 s	Part No.	Part No.
25 / 30 mm	18 mm	30 mm	25/25 mm ²	4.9 kA	725 115	725 802
25 / 30 mm	18 mm	30 mm	35/35 mm ²	6.9 kA	735 115	735 802
25 / 30 mm	18 mm	30 mm	50/25 mm ²	9.9 kA	750 803	750 802
25 / 30 mm	18 mm	30 mm	70/35 mm ²	13.8 kA	770 803	770 802
25 / 30 mm	18 mm	—	95/35 mm ²	18.7 kA	795 803	795 802
25 / 30 mm	—	—	120/50 mm ²	23.7 kA	712 803	712 802

Part No.	Part No.
725 115	725 802
735 115	735 802
750 803	750 802
770 803	770 802
795 803	795 802
712 803	712 802



UEK 30 HG

Fixed ball point Ø	Phase T pin Collar width	Rd / Fl Clamping range	Cable cross section	Max. short-circuit current I_k 1 s	Part No.
25 / 30 mm	18 mm	30 mm	25/25 mm ²	4.9 kA	725 806
25 / 30 mm	18 mm	30 mm	35/35 mm ²	6.9 kA	735 806
25 / 30 mm	18 mm	30 mm	50/25 mm ²	9.9 kA	750 806
25 / 30 mm	18 mm	30 mm	70/35 mm ²	13.8 kA	770 806
25 / 30 mm	18 mm	—	95/35 mm ²	18.7 kA	795 806
25 / 30 mm	—	—	120/50 mm ²	23.7 kA	712 806

Part No.
725 806
735 806
750 806
770 806
795 806
712 806

Other cable lengths as well as types with unreduced cross sections of earthing cables, other earth clamps and earth connection units are available on request. Earthing rod is not included in delivery.

SAFETY EQUIPMENT

Three-pole Earthing and Short-circuiting Devices

EARTHING AND SHORT-CIRCUITING DEVICES

Universal clamp, clamping
range 25 / 30 mm, T pin shaft

IEC/EN 61230 (DIN VDE 0683 Part 100)

Earth connecting elements

Phase connecting elements



EAS EK FM 12



EAB RN 16 FS

Fixed ball point Ø	Phase T pin Collar width	Rd / Fl Clamping range	Cable cross section	Max. short-circuit current I_k 1 s
25 / 30 mm	18 mm	30 mm	25/25 mm ²	4.9 kA
25 / 30 mm	18 mm	30 mm	35/35 mm ²	6.9 kA
25 / 30 mm	18 mm	30 mm	50/25 mm ²	9.9 kA
25 / 30 mm	18 mm	30 mm	70/35 mm ²	13.8 kA
25 / 30 mm	18 mm	—	95/35 mm ²	18.7 kA
25 / 30 mm	—	—	120/50 mm ²	23.7 kA

Part No.	Part No.
725 813	725 816
735 813	735 816
750 813	750 816
770 813	770 816
795 813	795 816
712 813	712 816

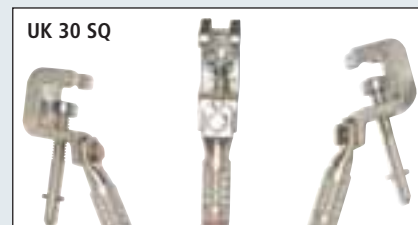

UK 30 SQ



UEK 30 FS



EFK FL30 SKN

Fixed ball point Ø	Phase T pin Collar width	Rd / Fl Clamping range	Cable cross section	Max. short-circuit current I_k 1 s
25 / 30 mm	18 mm	30 mm	25/25 mm ²	4.9 kA
25 / 30 mm	18 mm	30 mm	35/35 mm ²	6.9 kA
25 / 30 mm	18 mm	30 mm	50/25 mm ²	9.9 kA
25 / 30 mm	18 mm	30 mm	70/35 mm ²	13.8 kA
25 / 30 mm	18 mm	—	95/35 mm ²	18.7 kA
25 / 30 mm	—	—	120/50 mm ²	23.7 kA

Part No.	Part No.
725 117	725 811
735 117	735 811
750 812	750 811
770 812	770 811
795 812	795 811
712 812	712 811



UEK 30 HG

Fixed ball point Ø	Phase T pin Collar width	Rd / Fl Clamping range	Cable cross section	Max. short-circuit current I_k 1 s
25 / 30 mm	18 mm	30 mm	25/25 mm ²	4.9 kA
25 / 30 mm	18 mm	30 mm	35/35 mm ²	6.9 kA
25 / 30 mm	18 mm	30 mm	50/25 mm ²	9.9 kA
25 / 30 mm	18 mm	30 mm	70/35 mm ²	13.8 kA
25 / 30 mm	18 mm	—	95/35 mm ²	18.7 kA
25 / 30 mm	—	—	120/50 mm ²	23.7 kA

Part No.
725 815
735 815
750 815
770 815
795 815
712 815

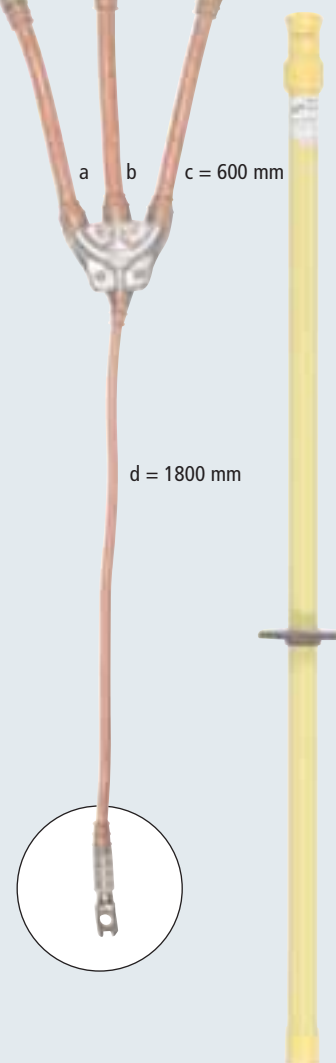

Other cable lengths as well as types with unreduced cross sections of earthing cables, other earth clamps and earth connection units are available on request. Earthing rod is not included in delivery.

Three-pole Earthing and Short-circuiting Devices

SAFETY EQUIPMENT

Short-circuiting bar

EARTHING AND SHORT-CIRCUITING DEVICES

EN/IEC 61230 (DIN VDE 0683 Part 100)

- With longitudinal slot for reliable contact
- For copper or aluminium busbars up to a thickness of 25 mm
- Other bar and earthing cable lengths available on request
- Operation by earthing rods with hexagon or T pin shaft



Short-circuiting bar with earthing cable in a switchgear installation.

The short-circuiting bar with longitudinal slot can be used for installations with compensated systems.

The earthing cable is fitted with a ball head cap with wing nut for fixed ball points Ø20 mm for connection to the earthing system (other equipment is available on request).

The short-circuiting bars are available with 2 different coupling devices for operation with earthing rods:

Technical Data

Earthing cable	Cu, highly flexible
Cable cross section	50 mm ²
Cable length	2500 mm
Operating temperature range	- 25° C ... + 55° C



SK: Hexagon shaft

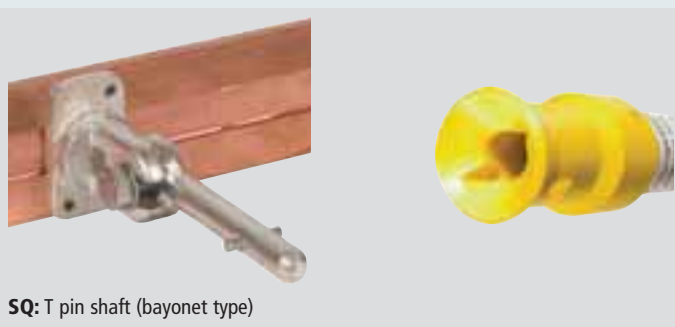

SQ: T pin shaft (bayonet type)

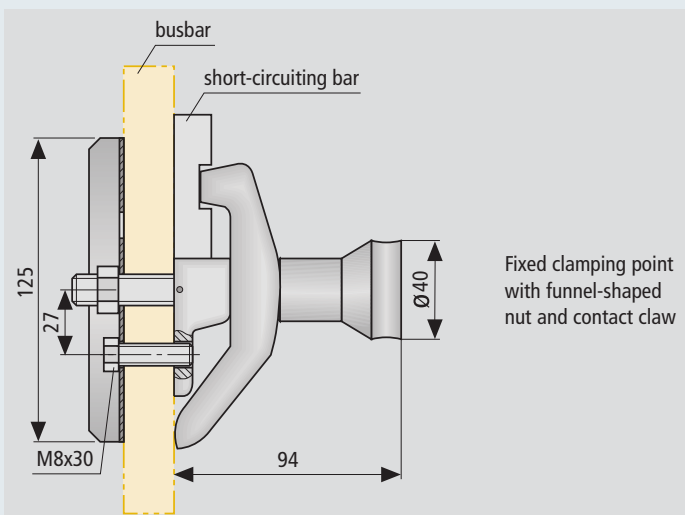

SAFETY EQUIPMENT

Three-pole Earthing and Short-circuiting Devices

EARTHING AND SHORT-CIRCUITING DEVICES

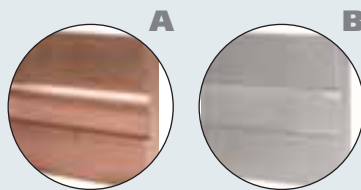

Type	Coupling device	Profile h x w	Total length l_G	Max. short-circuit current I_k 1 s	Part No.
------	-----------------	---------------	--------------------	--------------------------------------	----------

A Short-circuiting Bar made of E-Cu F20

KSS 60 8 CU SK	SK	60 x 8 mm	520 mm	70.0 kA	795 038
KSS 60 12 CU SK	SK	60 x 12 mm	520 mm	90.0 kA	795 039
KSS 60 8 CU SQ	SQ	60 x 8 mm	520 mm	70.0 kA	795 041
KSS 60 12 CU SQ	SQ	60 x 12 mm	520 mm	90.0 kA	795 045

B Short-circuiting Bar made of AlMgSi 0.5

KSS 60 8 AL SK	SK	60 x 8 mm	520 mm	45.0 kA	795 042
KSS 60 12 AL SK	SK	60 x 12 mm	520 mm	70.0 kA	795 043
KSS 60 8 AL SQ	SQ	60 x 8 mm	520 mm	45.0 kA	795 048
KSS 60 12 AL SQ	SQ	60 x 12 mm	520 mm	70.0 kA	795 049

Note: Please specify the bar distance (S_A) and bar width (S_B) when placing your order.

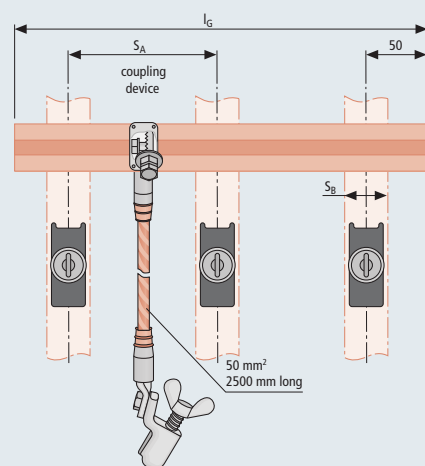
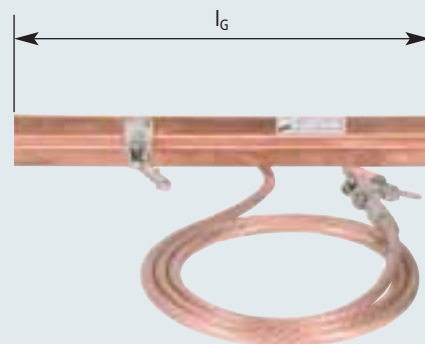

Accessories for Three-pole Earthing and Short-circuiting Devices

Fixed Clamping Points for Busbars

With funnel-shaped nut and contact claw

Type	Part No.
KLFP M12 KSS	795 040

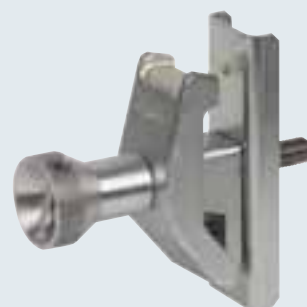

SK Screw Adapter

Hexagon terminal, width across flats 19

Type	Total length l_G	Part No.
SA KLFP SK	60 mm	795 214



SQ Screw Adapter

T pin shaft (bayonet type)

Type	Total length l_G	Part No.
SA KLFP SQ	100 mm	795 213

